



**SF-120**

CFA  
CAP

Hydraulic CFA  
Rotary Rig

Hydraulic CFA Rotary Rig **SF-120**

**soilmec**   
Drilling and Foundation Equipment



## Rotary

Soilmec rotaries are designed and manufactured to meet the need of performance and high production rate on various applications, with the added benefit of increased component life and reliability.

## Ease of transport and quick assembly

- Counterweight with a self-handling system (service crane not required).
- Crawlers can be retracted under 3,5 m wide.

## Compact powerful engine

Soilmec installs large displacement engines, providing exceptional performance and reliability.

- High performance, availability and reliability by using tried-and-tested technology with high power-to volume-ratio.
- The modern electronic injection system ensures low fuel consumption and therefore low operating costs.
- Low noise emissions, smooth running characteristics and durability.
- Meets exhaust emission regulations 2004/26/EU, Step III A and US-EPA Tier 3.

## DMS control system

DMS is an innovative system, developed by Soilmec, which controls and monitors the operation of the machine. For ease of operation the system is controlled by a touch screen located in the cab. The system main function, is to enable the machine to perform different functions more efficiently.

A dedicated power module electronic control system ensures the main pumps and diesel engine work at their most effective and productive levels.

## Ergonomic design

The cab is designed to be spacious, quiet and comfortable for the operator, assuring high productivity throughout the working day. Controls are conveniently located for easy operation.

## The Soilmec advantage

- A real multifunctional machine, designed from scratch to give you the chance of any market opportunity .
- Long life expectancy with a high residual value.
- Best price/performance ratio.
- Built with the customer in mind.







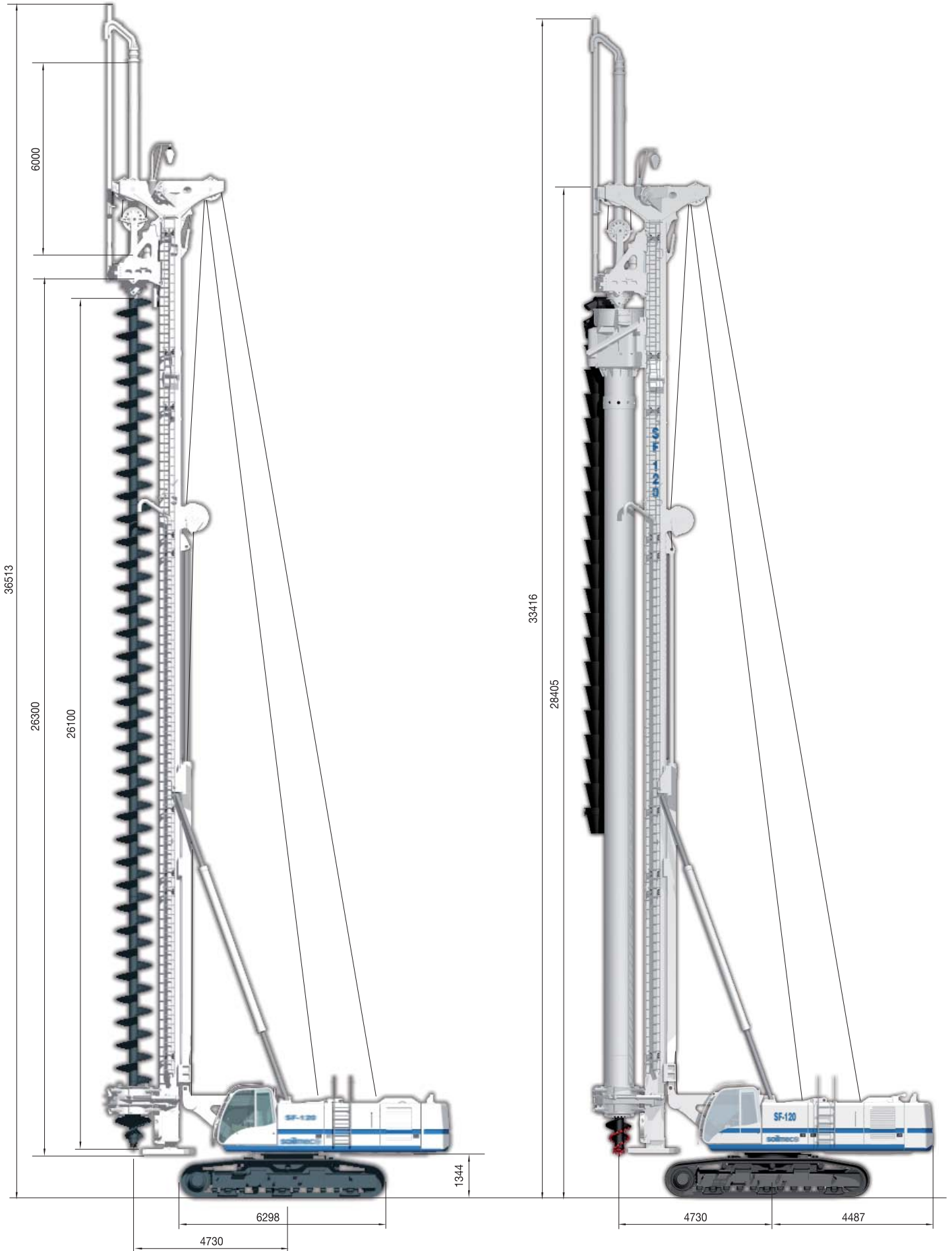

- 1** Turret
- 2** Undercarriage
- 3** Cab
- 4** Openable lower guide
- 5** Continuous flight auger
- 6** Rotary head
- 7** Cathead
- 8** Sleeve extension
- 9** Mast
- 10** Foot element

Deutz TCD 2015 V08		
Power 2000 rpm	<b>350 kW</b>	469 HP
Operating weight	<b>100000 kg</b>	220462 lb
Torque	<b>300 kNm</b>	221265 lbfft
Max diameter	<b>1200 mm</b>	47 in
Max depth	<b>31 m</b>	101.7 ft

# CFA / CAP - WORKING CONDITION



	<b>Overall height</b>	<b>36513 mm</b>	<b>1438 in</b>
	<b>Operating weight (approx)</b>	<b>105000 kg</b>	<b>220462 lb</b>
	<b>Rotary Drive - single gear type</b>		
	- Torque (nominal)	<b>300 kNm</b>	<b>221265 lbf*ft</b>
	- Speed of rotation (max)	<b>24,2 rpm</b>	<b>24.2 rpm</b>
	<b>Main winch SW 290</b>	<b>controlled descent</b>	<b>controlled descent</b>
	- Line pull (1st layer)	<b>290 kN</b>	<b>65193 lbf</b>
	- Rope diameter	<b>30 mm</b>	<b>1.19 in</b>
	- Rope length	<b>37 m / 84 m / 134 m</b>	<b>121 ft / 276 ft / 340 ft</b>
	- Line speed (max.)	<b>78 m/min</b>	<b>256 ft/min</b>
	<b>Auxiliary winch SW 140</b>	<b>controlled descent</b>	<b>controlled descent</b>
	- Line pull (1st layer)	<b>145 kN</b>	<b>32597 lbf</b>
	- Rope diameter	<b>26 mm</b>	<b>1.02 in</b>
	- Line speed (max.)	<b>90 m/min</b>	<b>295 ft/min</b>
	<b>CFA (Continuous Flight Auger)</b>		
	- Max pile diameter	<b>1200 mm</b>	<b>47.24 in</b>
	- Max pile depth w/o auger cleaner	<b>30,5 (24,5 + 6) m</b>	<b>100 (80.4 + 20) ft</b>
	- Max pile depth with auger cleaner	<b>29 m (23 + 6)</b>	<b>95 (75.5 + 20) ft</b>
	- Max Extraction force	<b>1160 kN</b>	<b>260774 lbf</b>
	- Length of auger string	<b>24,5 m</b>	<b>80 ft</b>
	<b>CAP (Cased Augered Piles)</b>		
	- Max pile diameter	<b>1000 mm</b>	<b>39.37 in</b>
	- Max pile depth	<b>27 m</b>	<b>88.6 ft</b>
	- Max cased depth	<b>21 m</b>	<b>68.9 ft</b>
	- Casing pull up / down	<b>410 kN</b>	<b>92170 lbf</b>
	- 2nd rotary max torque	<b>440 kNm</b>	<b>324522 lbf*ft</b>
	- Max casing speed	<b>5,7 rpm</b>	<b>5.7 rpm</b>
	<b>Mast inclination</b>		
	- Backward / Forward / Lateral	<b>10° / 4° / 3°</b>	<b>10° / 4° / 3°</b>

Soilmec integrates high quality level components: Gearmatic, Hydromatic, Lohmann, Rothe erde, Trasmital, Zollern.



## Standard equipment

- Oscillator attachment
- Central lubrication system
- Emergency mode of operation for engine
- Engine diagnostic system
- Diagnostic panel for hydraulic functions
- Removable counterweight
- Transport securing lugs on crawler units
- Access ladder on upper carriage
- On-board lighting set
- On-board tool set
- Electric refuelling pump
- High-comfort operator's cab
- Protective roof grate (FOPS compliant)
- Air conditioning system
- Radio and CD player

## Optional equipment

- Base carrier**
  - Biodegradable oil
  - Pressurized air conditioning system
- Drilling Equipment**
  - Swivel for auxiliary rope
  - Videocamera attachment
  - Pull down winch (207 kN)

## TECHNICAL DATA - BASE CARRIER

	<b>Engine</b>	<b>Deutz TCD2015 V08</b>	<i>Deutz TCD2015 V08</i>
	- Rated output ISO 3046-I	<b>350 kW @ 2000 rpm</b>	<i>469 HP @ 2000 rpm</i>
	- Engine conforms to Exhaust emission Standard	<b>EU stage III / US EPA Tier 3</b>	<i>EU stage III / US EPA Tier 3</i>
	- Diesel tank capacity	<b>350 l</b>	<i>92 US gal</i>
	- Sound pressure level in cabin (EN791 Annex A)	<b>75 dB (A)</b>	<i>75 dB (A)</i>
	- Sound power level (2000/14EG u. EN791, Annex A)	<b>106 dB (A)</b>	<i>106 dB (A)</i>
	<b>Hydraulic system</b>		
	- Main pump	<b>2x 300 l/min</b>	<i>79 US gal/min</i>
	- Working pressure	<b>30 MPa</b>	<i>4351 psi</i>
	- Auxiliary pump	<b>44 l/min</b>	<i>12 US gal/min</i>
	<b>Undercarriage (retractable crawler frames)</b>		
	- Track shoes width	<b>900 mm</b>	<i>35 in</i>
	- Overall width of crawlers retracted	<b>3400 mm</b>	<i>134 in</i>
	- Overall width of crawlers extended	<b>5000 mm</b>	<i>197 in</i>
	- Overall length of crawlers	<b>6300 mm</b>	<i>248 in</i>
	- Traction force	<b>743 kN</b>	<i>167030 lbf</i>
	- Travel speed	<b>2,1 km/h</b>	<i>1.3 mph</i>

\* Soilmec integrates high quality level components: Berco, Rexroth, Trasmital.

## Rotary RD-130

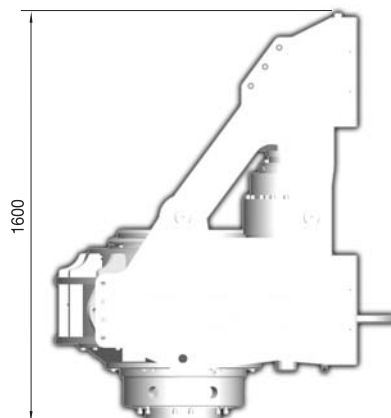
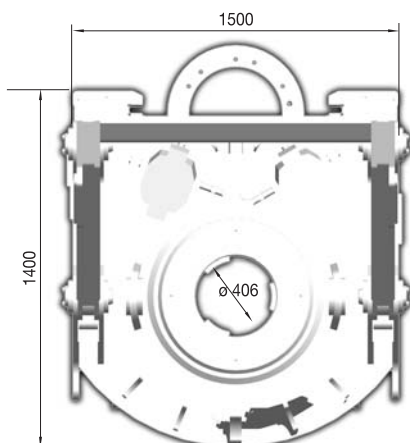
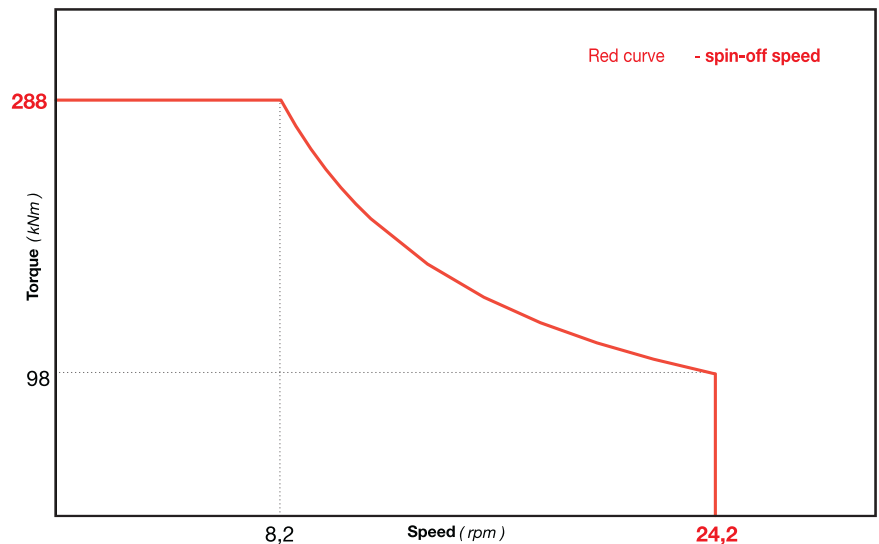
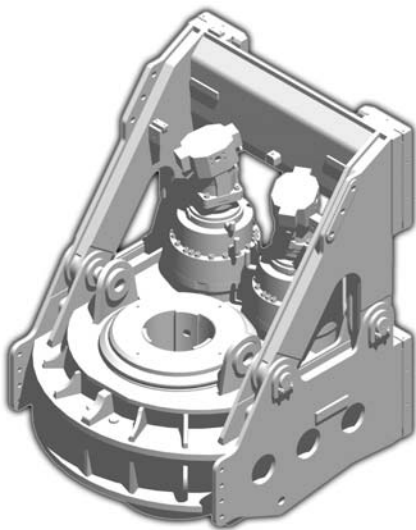

Rotary	Weight
Single gear version	<b>5000 kg</b> 11023 lbs

## TRANSPORT DATA

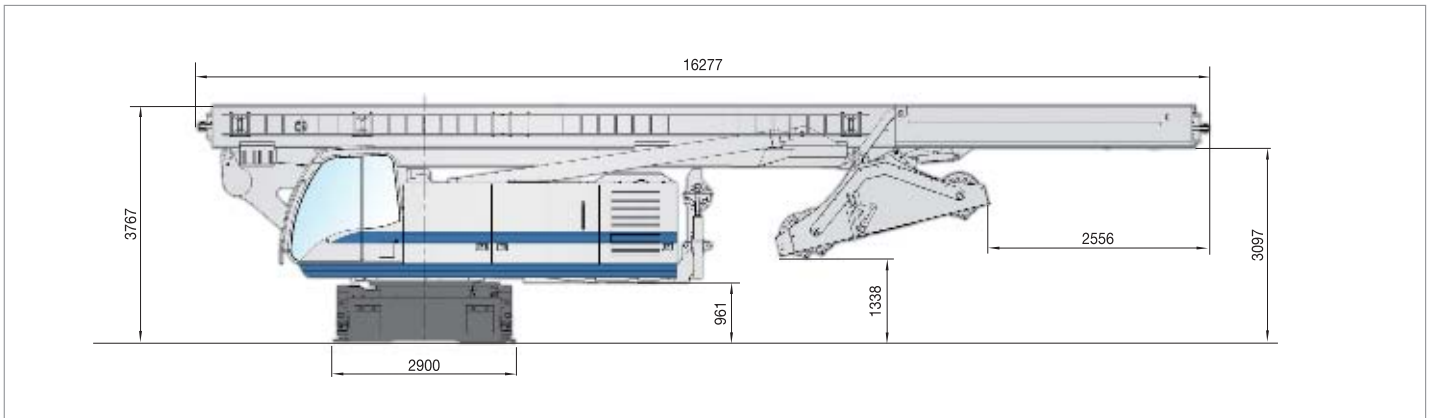

Transport w/o rotary, counterweight and crawler

Weight

**55000 kg**

121254 lb

## FOCUS - DMS

# DMS

**DRILLING MATE SYSTEM**

Soilmec innovative DMS - Drilling Mate System - has been designed to incorporate:

- CAN OPEN bus system
- colour touch screen suitable for the drilling field

DMS consists of 3 items:

- **DMS**
- **DMS PC**
- **DMS MANAGER**

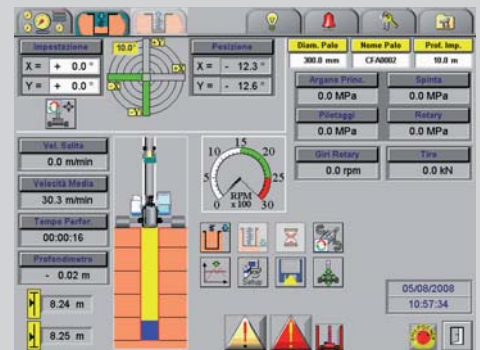

The **CFA Soilmec rigs** are equipped with the **DRILLING MATE SYSTEM (DMS)** operated through a 12" touch screen to control and monitoring the operating parameters as well as productive data.

The **standard DMS equipment** is composed of:  
 PLC - controller for all electrically actuated functions  
 - fault checking and reporting  
 - monitor unit designed to display:

- engine information and diagnostic capability
- pump pressures
- mast verticality
- drilling depth
- rotary speed and pressure
- crowd pressure
- graphics drilling charts

The following additional optional features are available:

- automatic turret hole centering
- automatic mast verticality
- recording of operating data on memory card

**DMS PC** software package to analyze and print production data and job site daily reports

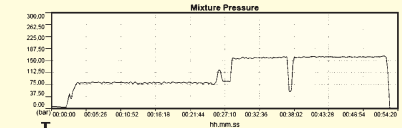

**DMS MANAGER** for remote control and transmission of process and operating data and tele assistance





SOILMEC distributes machinery and structures all over the world, supported by SOILMEC subsidiary companies and dealers.  
The complete Soilmec network list is available on the webpage [www.soilmec.it](http://www.soilmec.it)